

legni

woods · bois · holz · hout · maderá



rovere grigio
grey oak
chêne gris
Eiche grau
grijs eiken
roble gris



rovere laccato nero
black lacquered oak
chêne laqué noir
schwarz lackierter Eiche
zwart gelakt eiken
roble lacado negro

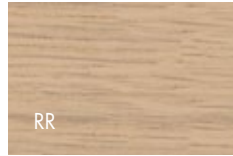

rovere naturale
natural oak
chêne naturel
Natur Eiche
eikenhout natuur
roble natural



rovere tabacco
tobacco oak
chêne tabac
Eiche Tabak
eikenhout tabak
roble tabaco



rovere laccato bianco
white lacquered oak
chêne laqué blanc
weiß lackierter Eiche
wit gelakt eiken
roble lacado blanco

laccati lucidi

glossy lacquered · lacqué brilliant · glänzende lackiert · glanzend gelakt · laqueado pulido

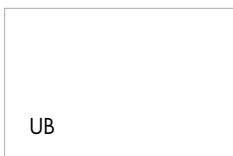

bianco
white
blanc
Weiß
wit
blanco

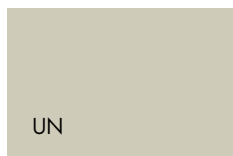

nebbia
mist
brouillard
Nebelgrau
mist
niebla



tortora
turtledove
tourterelle
Turteltaube
tortelduif
tórtola

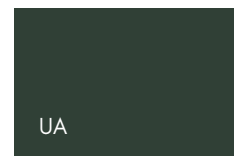

titanio
titanium
titane
Titan
titanium
titanio



moka
moka
moka
Moka
moka
moka

ante vetro retrolaccato

colored glass doors · portes en verre laqué · umseitige lackierte glastüren
deuren gelakt glas · puertas de vidrio retro-lacado

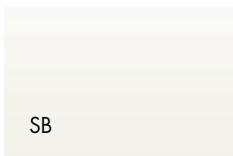

bianco
white
blanc
Weiß
wit
blanco

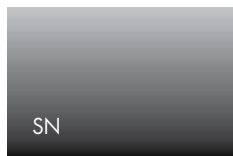

nero
black
noir
Schwarz
zwart
negro



nebbia
mist
brouillard
Nebelgrau
mist
niebla

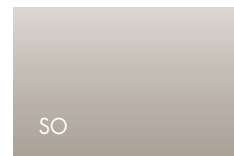

tortora
turtledove
tourterelle
Turteltaube
tortelduif
tórtola

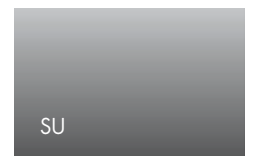

titanio
titanium
titane
Titan
titanium
titanio

ante vetro · parti metalliche · scocche armadi

glass doors · portes en verre · türen glas · glazen deurtjes · puertas de vidrio
metal parts · pièces métalliques · metallteile · metalen onderdelen · piezas de metal
cabinets frames · armoires coque · schränke korpuse · kasten structuur · estructura armarios



bi-satinato
frosted on both side
satiné sur le 2 faces
beidseitig satiniertes
tweezijdig gesatineers
bi-satinado



cromo lucido
glossy chrome
chromé brillant
Chrom poliert
glanzend verchromd
cromo pulido

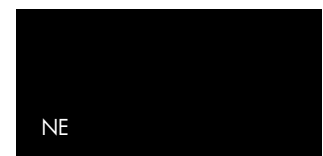

laccato nero lucido
gloss black lacquered
laqué noir brillant
glänzend Schwarz lackiert
zwart Glanzend gelakt
laqueado negro pulido

technical info

scrivania in legno · wooden desk · bureaux en bois · holz-schreibtische · houten bureaus · escritorio de madera

L x P x H

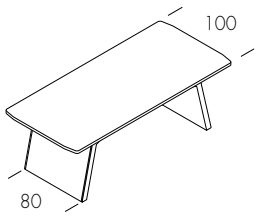

220 x 100 x 75 cm
240 x 100 x 75 cm

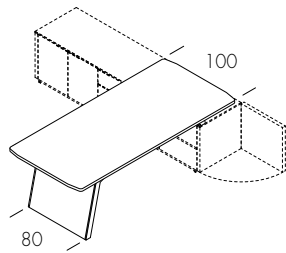

220 x 100 x 75 cm
240 x 100 x 75 cm

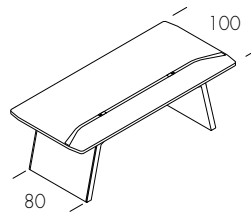

220 x 100 x 75 cm
240 x 100 x 75 cm

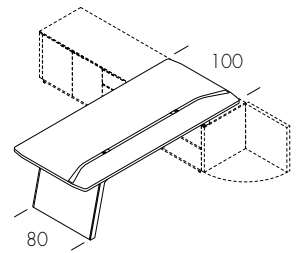

220 x 100 x 75 cm
240 x 100 x 75 cm

pannello modesty · modesty panel · voile de fond · knieraumbledend · bureauborden · panela para escritorio

L x T x H

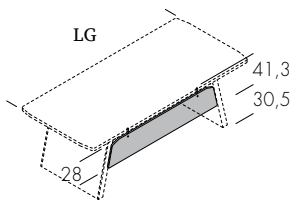

LG 220 140,6 x 1,9 x 41,3 cm
LG 240 160,6 x 1,9 x 41,3 cm

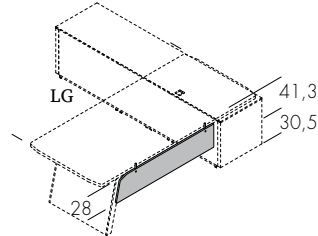

LG 220 121,5 x 1,9 x 41,3 cm
LG 240 141,5 x 1,9 x 41,3 cm

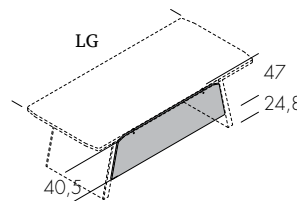

LG 220 151,6 x 1,9 x 47 cm
LG 240 171,6 x 1,9 x 47 cm

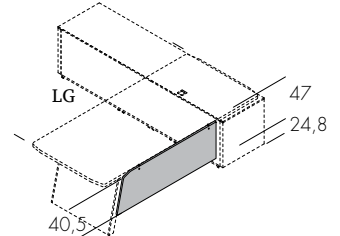

LG 220 126,9 x 1,9 x 47 cm
LG 240 146,9 x 1,9 x 47 cm

moduli di servizio · service modules · elements de service · multifunktionscontainer · servicemodulen · elementos de servicio

L x P x H

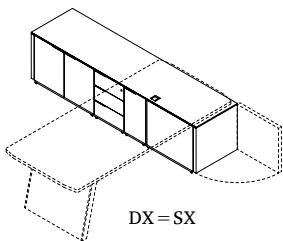

229 x 57,4 x 58,3 cm

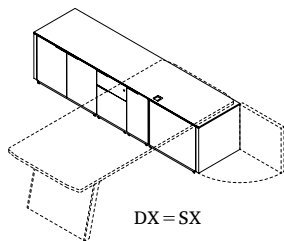

229 x 57,4 x 58,3 cm

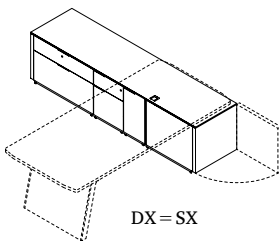

229 x 57,4 x 58,3 cm

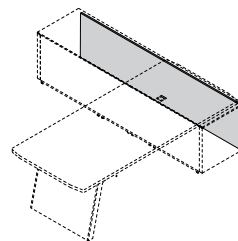

220,6 x 53,6 cm

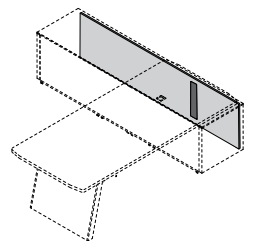

220,6 x 53,6 cm

moduli di servizio · service modules · elements de service · multifunktionscontainer · servicemodulen · elementos de servicio

L x P x H

credenze · sideboards · croyances · glauben · geloof · creencia

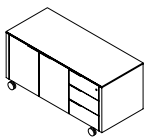

132,7 x 57,4 x 63,8 cm

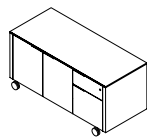

132,7 x 57,4 x 63,8 cm

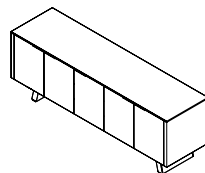

216 x 57,4 x 75 cm

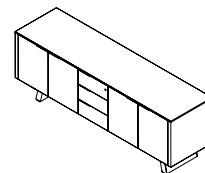

216 x 57,4 x 75 cm

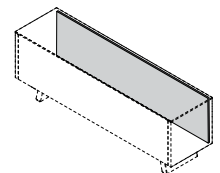

208,1 x 53,6 cm

armadi · cabinets · armoires · Schränke · kasten · armarios

L x H

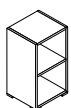

50 x 78,8 cm

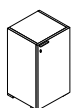

50 x 78,8 cm

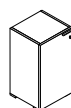

50 x 78,8 cm

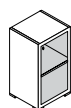

50 x 78,8 cm

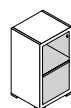

50 x 78,8 cm

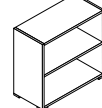

100 x 78,8 cm

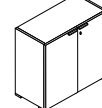

100 x 78,8 cm

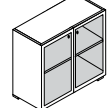

100 x 78,8 cm

armadi · cabinets · armoires · Schränke · kasten · armarios

L x H

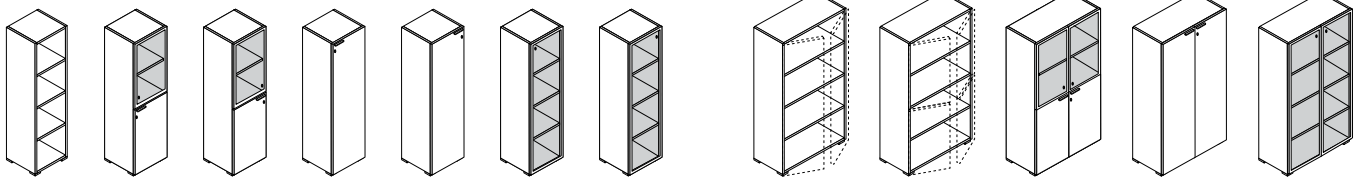

50 x 155,6 cm

100 x 155,6 cm

armadi · cabinets · armoires · Schränke · kasten · armarios

fianchi di chiusura · closing sides · flancs de finition · abschlussflanken · zupanelen · costados de cierre

L x H

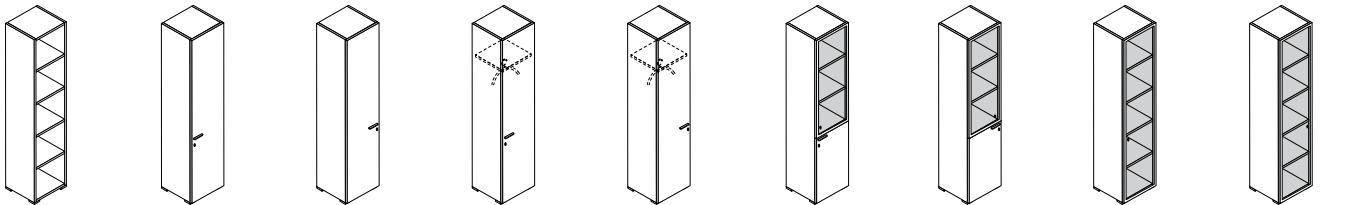

50 x 194 cm

50 x 194 cm

50 x 194 cm

50 x 194 cm

50 x 194 cm

50 x 194 cm

50 x 194 cm

50 x 194 cm

50 x 194 cm

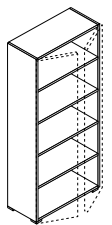

100 x 194 cm

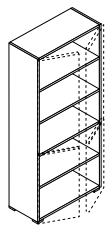

100 x 194 cm

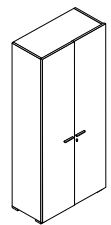

100 x 194 cm

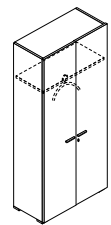

100 x 194 cm

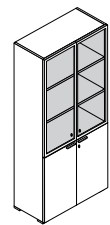

100 x 194 cm

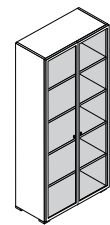

100 x 194 cm

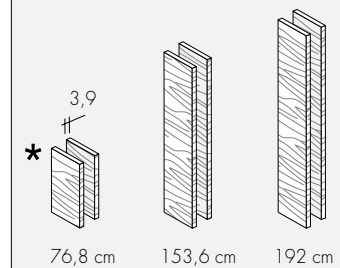

3,9

*

76,8 cm

153,6 cm

192 cm

top · top · top · abdeckplatte · topblad · parte superior

L x T



58 x 1,3 cm

108 x 1,3 cm

158 x 1,3 cm

208 x 1,3 cm

258 x 1,3 cm

308 x 1,3 cm

I top sono obbligatori sempre · The tops are compulsory per each arrangement · Les tops sont toujours obligatoires · Die Tops sind obligatorisch pro jede Anordnung
De toppen zijn verplichte per elke overeenkomst · Las tapas son obligatorias por cada arreglo

I fianchi di chiusura sono obbligatori sempre: 1 coppia per composizione · 1 pair of closing sides are always compulsory per each arrangement · Les côtés de fermeture sont toujours obligatoires: 1 paire par composition · Die Abschlussflanken sind ein Muss: 1 Paar für Komposition · De verplichte zijwanden voor sluiting steeds: 1 koppel per samenstelling · Siempre es obligatorio 1 par de costados de cierre por composición

piano conversazione · conversation top · plan conversation · platte für gesprächstisch · conferentiebladen · plano de conversación
cestelli portacavi · cables holder baskets · bac porte-cables · kabel halterkörbchen · korfjes voor el. bedrading · cestos portables

L x P x H

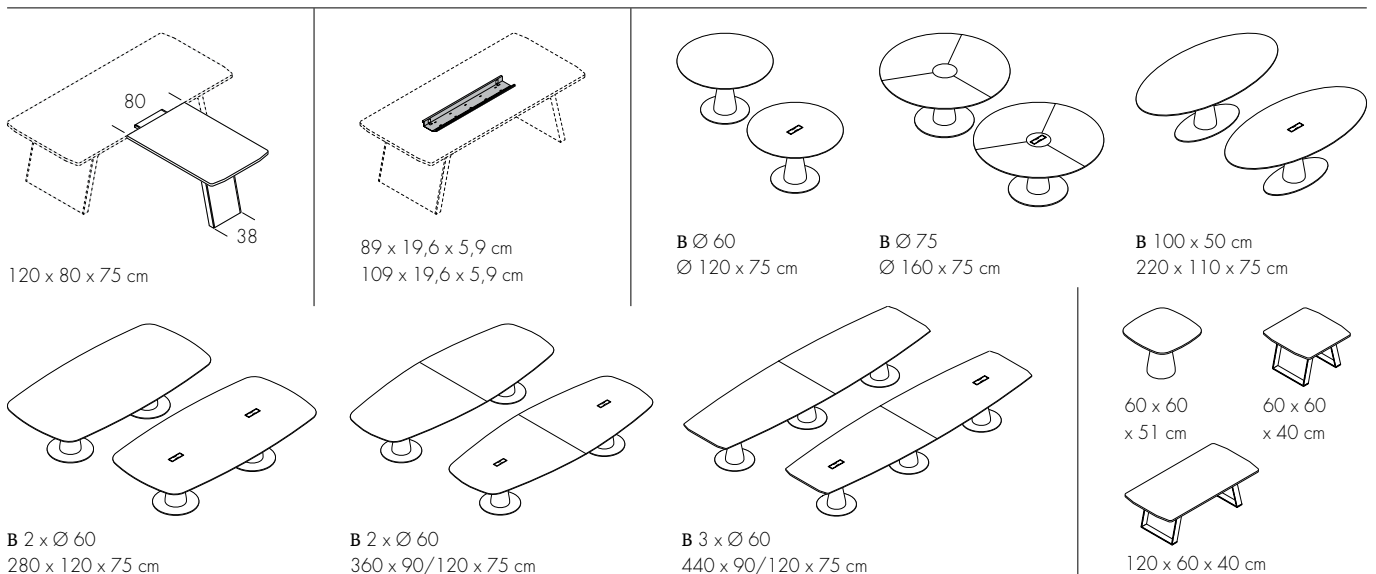

120 x 80 x 75 cm

89 x 19,6 x 5,9 cm
109 x 19,6 x 5,9 cm

B Ø 60
Ø 120 x 75 cm

B Ø 75
Ø 160 x 75 cm

B 100 x 50 cm
220 x 110 x 75 cm

B 2 x Ø 60
280 x 120 x 75 cm

B 2 x Ø 60
360 x 90/120 x 75 cm

B 3 x Ø 60
440 x 90/120 x 75 cm

60 x 60
x 51 cm

60 x 60
x 40 cm

120 x 60 x 40 cm